

CITIZEN

DOT MATRIX PRINTER

CD-S500 Series



CD-S500A

User's Manual

Table of Contents

COMPLIANCE STATEMENT FOR EUROPEAN USERS	3
FCC COMPLIANCE STATEMENT FOR AMERICAN USERS	3
EMI COMPLIANCE STATEMENT FOR CANADIAN USERS	4
ETAT DE CONFORMITE EMI A L'USAGE DES UTILISATEURS CANADIENS	5
Important Safety Instructions	6
Notice	7
SAFETY INSTRUCTIONS which must be strictly observed!	8

Chapter1 Introduction

Features	12
Explanation of the Models	13
Checking the Accessories	15

Chapter2 Names and Functions of Parts

.....	16
-------	----

Chapter3 Preparing the Printer

Connections	20
Installation	23
Setting the Paper Near End Sensor	24
Setting the Paper Width and Printing Line Column Number	25
Installing the Ribbon Cassette	27
Installing Roll Paper	28
Operation when the cover is opened and closed	33

Chapter4 Maintenance Mode

HEX Dump Mode	35
Soft SW Setting Mode	35
Initial Factory Shipping Mode	39
Cut Position Adjustment Mode	40
Error Indicators	41
Trouble Shooting	43

Chapter5 Appendixes

Specifications	44
Interface	48

COMPLIANCE STATEMENT FOR EUROPEAN USERS

CE marking shows conformity to the following criteria and provisions:

Low Voltage Directive (73/23/EEC)/EN60950-1

EMC Directive (89/336/EEC)/EN55022, EN55024, EN61000-3-2 & EN61000-3-3

FCC COMPLIANCE STATEMENT FOR AMERICAN USERS

This equipment has been tested and found to comply with the limits for a Class A digital device, pursuant to Part 15 of the FCC Rules. These limits are designed to provide reasonable protection against harmful interference when the equipment is operated in a commercial environment. This equipment generates, uses, and can radiate radio frequency energy and, if not installed and used in accordance with the instruction manual, may cause harmful interference to radio communications. Operation of this equipment in a residential area is likely to cause harmful interference in which case the user will be required to correct the interference at his own expense.

CITIZEN is a registered trade mark of CITIZEN WATCH CO., LTD., JAPAN

Company names and product names in this manual are trademarks or registered trademarks of relevant companies.

Copyright © 2005 CITIZEN SYSTEMS JAPAN CO., LTD.

EMI COMPLIANCE STATEMENT FOR CANADIAN USERS

This Class A digital apparatus complies with Canadian ICES-003.

This equipment generates and uses radio frequency energy and if not installed and used properly, that is, in strict accordance with the manufacturer's instructions, may cause interference to radio and television reception. This digital apparatus does not exceed the Class A limits for radio noise emissions from digital apparatus set out in the Radio Interference Regulations of the Canadian Department of Communications. This equipment is designed to provide reasonable protection against such interference in a residential installation. However, there is no guarantee that interference will not occur in a particular installation. If this equipment does cause interference to radio or television reception, which can be determined by turning the equipment off and on, the user is encouraged to try to correct the interference by one or more of the following measures:

- Reorient or relocate the receiving antenna.
- Increase the separation between the equipment and receiver.
- Connect the equipment into an outlet on a circuit different from that to which the receiver is connected.
- Consult the dealer or an experienced radio/TV technician for help.

CAUTION : Use shielded cables to connect this device to computers.

Any changes or modifications not expressly approved by the grantee of this device could void the user's authority to operate the equipment.

ETAT DE CONFORMITE EMI A L'USAGE DES UTILISATEURS CANADIENS

Cet appareil numérique de la classe A est conforme à la norme NMB-003 du Canada.

Cet équipement produit et utilise l'énergie à radiofréquences et s'il n'est pas installé et utilisé correctement, c'est à dire en accord strict avec les instructions du fabricant, il risque de provoquer des interférences avec la réception de la radio et de la télévision.

Le présent appareil numérique n'émet pas de bruits radio électriques dépassant les limites applicables aux appareils numériques de la classe A prescrites dans le Règlement sur le brouillage radioélectrique édicté par le ministère des Communications du Canada.

Cet équipement est conçu pour fournir une protection satisfaisante contre de telles interférences dans une installation résidentielle. Cependant, il n'y a pas de garantie contre les interférences avec les réceptions radio ou télévision, provoquées par la mise en et hors circuit de l'équipement; aussi, il est demandé à l'utilisateur d'essayer de corriger l'interférence par l'une ou plus des mesures suivantes:

- Réorienter l'antenne de réception.
- Installer l'ordinateur autre part, par égard pour le récepteur.
- Brancher l'ordinateur dans une prise de courant différente de façon à ce que l'ordinateur et le récepteur soient branchés sur des circuits différents.

Important Safety Instructions

- Read all of these instructions and save them for later reference.
- Follow all warnings and instructions marked on the product.
- Unplug this product from the wall outlet before cleaning. Do not use liquid or aerosol cleaners. Use a damp cloth for cleaning.
- Do not use this product near water.
- Do not place this product on an unstable cart, stand or table. The product may fall, causing serious damage to the product.
- Slots and openings on the cabinet and the back or bottom are provided for ventilation. To ensure reliable operation of the product and to protect it from overheating, do not block or cover these openings. The openings should never be blocked by placing the product on a bed, sofa, rug or other similar surface. This product should never be placed near or over a radiator or heat register. This product should not be placed in a built-in installation unless proper ventilation is provided.
- This product should be operated from the type of power source indicated on the marking label.
If you are not sure of the type of power available, consult your dealer or local power company.
- This product is equipped with a three-pronged plug, a plug having a third (grounding) pin. This plug will only fit into a grounding-type power outlet. This is a safety feature. If you are unable to insert the plug into the outlet, contact your electrician to replace your obsolete outlet. Do not defeat the safety purpose of the grounding-type plug.
- Do not allow anything to rest on the power cord. Do not locate this product where the cord will be walked on.
- If an extension cord is used with this product, make sure that the total of the ampere ratings on the products plugged into the extension cord do not exceed the extension cord ampere rating. Also, make sure that the total of all products plugged into the wall outlet does not exceed 15 amperes for 120V outlet and 7.5 amperes for 220V-240V outlet.
- Never push objects of any kind into this product through cabinet slots as they may touch dangerous voltage points or short out parts that could result in a risk of fire or electric shock. Never spill liquid of any kind on the product.
- Except as explained elsewhere in this manual, don't attempt to service this product yourself. Opening and removing those covers that are marked "Do Not Remove" may expose you to dangerous voltage points or other risks. Refer all servicing on those compartments to service personnel.

- The main plug on this equipment must be used to disconnect mains power. Please ensure that the socket outlet is installed near the equipment and shall be easily accessible.
- Unplug this product from the wall outlet and refer servicing to qualified service personnel under the following conditions:
 - A. When the power cord or plug is damaged or frayed.
 - B. If liquid has been spilled into the product.
 - C. If the product has been exposed to rain or water.
 - D. If the product does not operate normally when the operating instructions are followed. Adjust only those controls that are covered by the operating instructions since improper adjustment of other controls may result in damage and will often require extensive work by a qualified technician to restore the product to normal operation.
 - E. If the product has been dropped or the cabinet has been damaged.
 - F. If the product exhibits a distinct change in performance, indicating a need for service.

Notice

- Before use, be sure to read this manual. And keep it handy for reference when needed.
- The contents of this manual may change without prior notice.
- Reproduction, transfer, or transmission of the contents of this manual without prior consent is strictly prohibited.
- We are not liable for any damage resulting from the use of the information contained herein, regardless of errors, omissions, or misprints.
- We are not liable for any problems resulting from the use of optional products and consumable supplies other than the designated products contained herein.
- Do not handle, disassemble or repair the parts other than those specified in this manual.
- We are not liable for any damage caused by user's erroneous use of the printer and inadequate environment.
- Data residing in the printer is temporary. Therefore, all data will be lost if power is lost. We are not liable for any damage or loss of profits caused by data loss due to failures, repairs, inspections, etc.
- Please contact us if there are any mistakes or ambiguities within this manual.
- If there are missing or incorrectly collated pages in this manual, contact us to obtain a new manual.

SAFETY INSTRUCTIONS

which must be strictly observed !

- To prevent personal injury or property damage, the following shall be strictly observed.
- The degree of possible injury and damage due to incorrect use or improperly following instructions is described below.



Warning

Indicates a situation which, if not observed and handled properly, could result in death or serious injury.



Caution

Indicates a situation which, if not observed and handled properly, could result in injury.

Meaning of symbols



This symbol indicates that something must be handled carefully.



This symbol indicates something that must not be done.



This symbol indicates something that must be done.



Warning

Never perform the following. If not avoided, these may cause damage or trouble to the printer or cause the printer to overheat and release smoke and cause burns or an electrical shock. If the printer is damaged or is malfunctioning, be sure to turn the printer off immediately and remove the power cord from the outlet, then consult our service personnel.

- Do not place the printer in a poorly ventilated area, or shut off the air vent of the printer.
- Do not place the printer where chemical reactions occur, such as in laboratories or where air is mixed with salt or gas.
- Do not use a power voltage or frequency other than those specified.
- Do not plug/unplug the power cord or attach/detach the interface cable by simply grabbing the power cord or interface cable. Do not pull or carry the printer when the tension of the power cord or interface cable is increased.
- Do not drop or put foreign matter such as clips and pins into the printer. This may cause problems.
- Do not plug the power cord into an outlet with many loads.
- Do not spill drinks such as tea, coffee and juice on the printer or spray insecticide on the printer. If drink or water is spilled, first be sure to turn the power off and remove the power cord from the outlet, then consult our service personnel.
- Do not disassemble or modify the printer.
- Do not use this printer when any safety switch built into the product has been cancelled without solving the problem that activated it. If you do, there is a danger that the printer will malfunction, injuring, burning, or electrocuting you.

Discard or safely store the plastic packing bag. This bag should be kept away from children. If the bag is pulled over a child's head, it may cause suffocation.

General Precautions



- Prior to operation, read the safety instructions carefully and observe them.
- Do not drop or put foreign matter such as clips and pins into the printer. This may cause problems.
- Be careful when moving or carrying the printer. Dropping the printer may cause injury or property damage.
- If this printer is accidentally dropped, be sure to notify a service person; do not try to repair it yourself.
- Do not open the printer during printing.
- When cleaning the surface of the printer case, do not use the cloth that is soaked in thinner, trichloroethylene, benzene, ketone or similar chemicals.
- Do not use the printer where there is a lot of oil, iron particles, or dust.
- Do not spill liquids or spray insecticide on the printer.
- Do not jolt or impact to the printer by stepping on, dropping or hitting the printer.
- Operate the control panel properly. A careless, rough handling may cause problems or malfunction. Do not use such sharp-edged tool as a ballpoint pen for operation.
- Be careful of the edges of the plates so injury or property damage is possible.
- If a problem occurs during printing, stop the printer immediately and unplug the power cord from the outlet.
- When printer trouble occurs, do not try to disassemble it. Instead, consult our service personnel.

Precautions When Installing the Printer



Caution

- Prior to operation, read the safety instructions carefully and observe them.
- Do not use or store the printer near fire, excessive moisture, in direct sunlight, near an air conditioner or heater or other source of unusually humidity or excessive dust.
- Do not place the printer where chemical reactions occur, such as in a laboratory.
- Do not place the printer where air is mixed with salt or gas.
- The printer must sit on a firm, level surface where there is ample ventilation. Never allow the printer's air vent to be blocked by an object.
- Do not put anything on the top of printer.
- Do not place the printer near a radio or television, and do not use the same wall outlet for the printer and radio or television. Radio or television reception could be adversely affected.
- Do not put anything on the power cord or step on it.
- Do not drag or carry the printer with the power cord or interface cable.
- Avoid plugging the power cord into an outlet with many loads.
- Do not bundle the power cord when inserting the plug.
- Always grip the plug housing, not the cord, to plug/unplug the power cord.
- Make certain the power is turned off before connecting/disconnecting the interface cable.
- Avoid lengthening the signal cable or connecting it to any noise-producing device. If it is unavoidable, use the shielded cable or twisted pair for each signal.
- Place the printer near the outlet where the power cord can be unplugged easily to shut off power.
- Use the AC outlet that accepts a three-pronged plug. Otherwise, static electricity may be generated and there will be danger of electric shock.
- Do not carry it holding the cover.
Doing this might break its mechanisms or cause it to malfunction.

Thank you very much for purchasing the Citizen Dot Matrix Printer CD-S500 series. This printer is a dot matrix printer developed for use with various kinds of data communication terminals, POS terminals, and kitchen printers. It can be used for a wide range of applications thanks to its rich selection of functions.

Features

- *Compact design*
- *A paper drop in mechanism that simplifies paper loading*
- *High speed printing to a maximum of 240cps*
- *Multiple copy printing (original form + 2 copies)*
- *Input buffer available*
- *Black mark sensor mechanism*
- *Versatile printing layout using the page mode*
- *Logo data or text data prepared by the user can be stored in its user memory*
- *Built-in drawer kick-out interface*
- *Optional auto-cutter (full cut/partial cut)*
- *Capacity for paper with widths of 76.2/69.5/57.5mm*
- *Serial (RS-232C) or Parallel (IEEE and Centronics compliant) interface is available as a factory option*
- *Selection of functions diversified by its operation panel (Soft SW setting mode)*
- *Can be wall mounted (optional)*
- *Built-in buzzer*
- *Built-in or external AC adapter types available*
- *Dual color printing (red/black)*

Explanation of the Models

Models in this series are identified by the following model naming method.

Model Number: CD-S - -

Model name

- 500 : Standard model
- 501 : Built-in auto cutter model
- 503 : Built-in auto cutter and rewinder model

Power source type

- A: AC adapter type
- S: Built-in AC adapter type

Interface

- PA : Parallel IEEE1284 compatible
- RS : Serial RS-232C compatible
- UB: USB

Region (Characters + power cord)

- J : Japan
- E : Europe
- U : North America
- C : China

Case Color

- WH : Cool white
- BK : Black

Black mark sensor

- None : No sensor
- M1 : Left sensor for paper reverse
- M2 : Right sensor for paper reverse
- M3 : Left sensor for paper surface
- M4 : Right sensor for paper surface

Explanation of models

Examples of models

■ Standard model (AC Adapter type)



CD-S500A□□□-□□-□□

■ Standard model (Built-in AC adapter type)



CD-S500S□□□-□□-□□

■ Auto cutter equipped model (AC Adapter type)



CD-S501A□□□-□□-□□

■ Auto cutter equipped model (Built-in AC adapter type)



CD-S501S□□□-□□-□□

■ Auto cutter and rewriter equipped model (AC Adapter type)



CD-S503A□□□-□□-□□

■ Auto cutter and rewriter equipped model (Built-in AC adapter type)



CD-S503S□□□-□□-□□

Checking the Accessories

Check to make sure that the following accessories are included with your printer.

- Printer: 1
- AC adapter: 1
(CD-S500A series only)
- Power cord: 1
- Ribbon cassette: 1
- Partition: 1
- Slip prevention rubber feet: 4
(CD-S500S and CD-S501S only)
- Sample roll paper: 1
- User's Manual (this document)

■ Printer: 1

- AC adapter type



- Built-in AC adapter type



* The AC adapter is set inside the AC adapter case.

- Power cord



- Ribbon cassette



- AC adapter



- Partition



- Sample roll paper



- User's Manual (this document)



Names and Functions of Parts

Exterior

■ AC adapter type

Standard and auto cutter equipped models

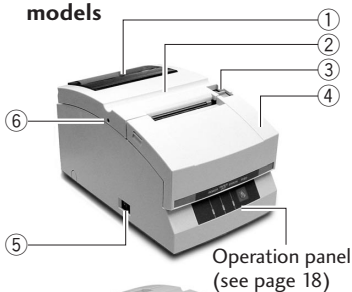

Auto cutter and rewinder equipped model

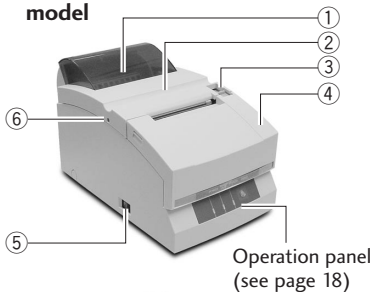

■ Built-in AC adapter type



- ① **Paper check window**
It can be used to check the amount of paper left on the roll.
- ② **Rear cover**
It can be opened to set or to replace a paper roll.
- ③ **Rear cover open lever**
It is a lever used to open the rear cover. Pull the lever towards you to open the rear cover.
- ④ **Front cover**
It can be opened to set or replace the ribbon cassette.
- ⑤ **Power switch**
It turns the printer power on and off.
- ⑥ **Cutter lock clearing screw hole**
When the rear cover cannot be opened because the blade of the auto cutter protrudes after a malfunction or as a result of a paper jam, turn this screw with a Phillips head screw driver to return the blade.
- ⑦ **AC adapter case**
This is installed only for the built-in AC adapter type.

Interior

■ AC adapter type

Standard and auto cutter equipped model

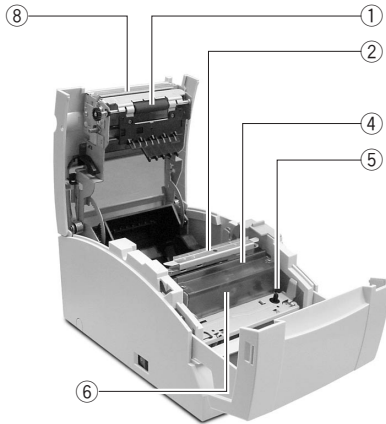

① Platen unit

In the standard and auto cutter equipped models, it is combined with ⑧ the auto cutter.

② Paper cut bar

It is used to cut the paper manually.

③ Platen open lever

It is a lever used to open the platen unit on the rewinder equipped model. Open the platen unit by pulling it towards you.

④ Print head cover

⑤ Ribbon cassette drive shaft

⑥ Print head

⑦ Rewinder shaft

It rewinds the copy side of the copy roll paper.

⑧ Auto cutter unit

It automatically cuts the paper after printing is completed. The cut action is set by a command in Soft SW Setting Mode.

Auto cutter and rewinder equipped model

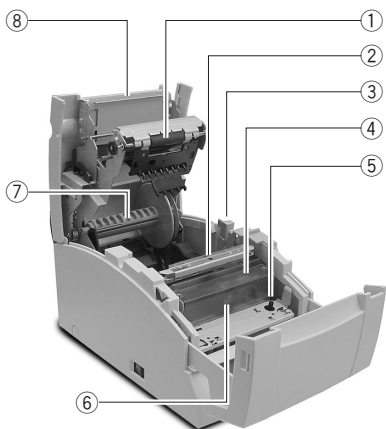

Operation Panel

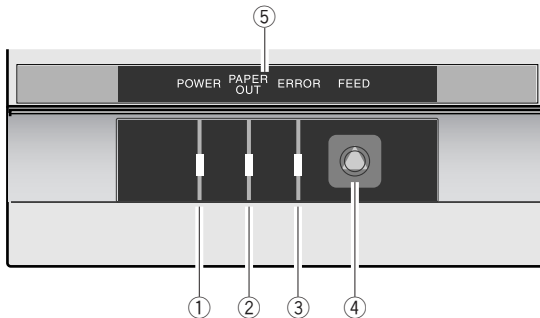

① POWER LED (Green)

It is lit when the power is supplied. When maintenance mode is set or there is an error indication, it is either lit or flashing.

② PAPER OUT LED (Orange)

It is lit in paper out status. When maintenance mode is set or there is an error indication, it is either lit or flashing.

③ ERROR LED (Orange)

It is lit when the rear cover or front cover is open. When maintenance mode is set or there is an error indication, it is either lit or flashing.

④ FEED Switch

When this switch is pressed once, paper feeds (1 line). If it is held down, paper feeds continuously until it is released. And when there is a printer error, pressing this switch can cancel the error status.

⑤ LED NAME SHEET

This sheet is used reversed according to the printer installation method. See Vertical Installation and Wall Mounted Installation (page 23).

Display when installed horizontally



Display when installed vertically or wall mounted



Rear Connectors

AC adapter type

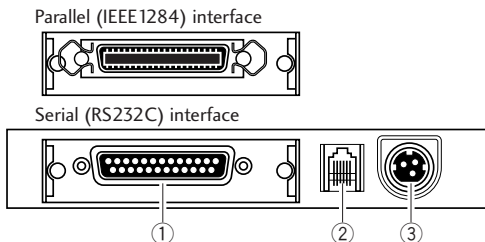

Built-in AC adapter type

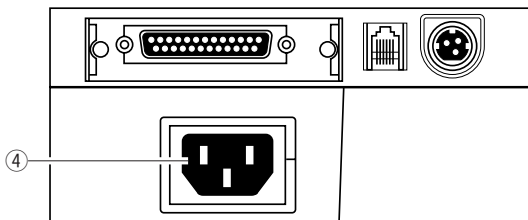

① Interface connector

It is connected to either a serial (RS232C) or parallel (IEEE1284) interface cable.

* A USB interface replaced by a serial or parallel interface will be available as a factory option.

② Drawer kick connector

It is connected to a cable from the drawer.

③ Power source connector

It is connected to a cable from the AC adapter.

④ Power source inlet

It is connected to the power cord.

Others

Built-in Buzzer

A buzzer sounds when the FEED switch is operated and when there is an error.

The buzzer can be switched between enabled and disabled in Soft SW setting mode.

User Memory

Logo data or text data prepared by the user can be stored in memory.

This stored data remains in memory even after the power is turned off.

Connections

Connecting the Interface Cable

Turn off the power to the printer and insert the connectors being careful about their orientation.



Caution

- Always hold the connector when pulling out a cable.
- Install the interface cable so that it will not be caught on your shoes etc.

■ Connecting the serial (RS232C) interface cable

Make sure that you insert it firmly and fix it in place by tightening the screw.

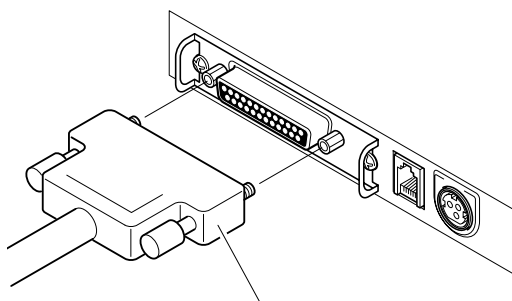

Serial (RS232C) interface cable

■ Connecting the parallel (IEEE1284) interface cable

Make sure that you insert it firmly and fix it in place by turning the attachment screws in the direction shown by the arrow.

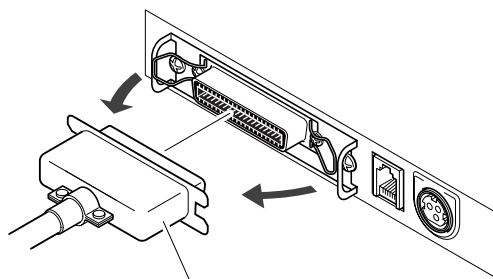

Parallel (IEEE1284) interface cable

Connecting the Drawer

Match the top and bottom of the drawer kick connector with the cable terminal and insert it firmly until you hear a click.

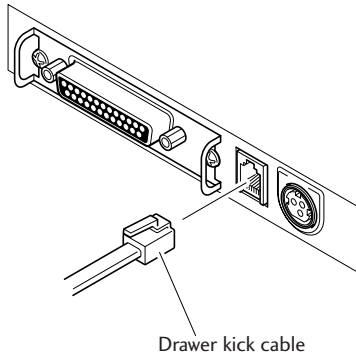

Caution

- Connect only a specialized drawer. **(Do not connect a telephone line.)**
- Output is impossible during printing.
- Drawer 1 and drawer 2 cannot be driven simultaneously.
- Use a drawer use solenoid that is at least 24Ω . Make sure that the output current is not higher than 1A. This may cause a malfunction or burn damage.
- Install the drawer kick cable so that it will not be caught on your shoes etc.

See page 48 for detailed specifications of the interfaces.

Connecting the Power

1. Make sure that the printer power switch is set to OFF.

2. If your printer is an AC adapter type, insert the AC adapter cable connector with its flat side upwards into the power connector on the rear surface of the printer.

If your printer is a built-in AC adapter type, insert the plug on the power cord into the AC inlet on the back surface of the printer.



Caution

- Do not use an AC adapter other than the stipulated product (Model 51AD).
- Always hold the connector when inserting or removing the cable connector of the AC adapter.
- Stretching the power cord by pulling it will damage it, causing fire, electric shocks, or a break in the conductor.
- When lightning is striking nearby, remove the plug of the power cord from the outlet. Lightning will cause fire or electric shock.
- Do not place the power cord near a heating device. The cover of the power cord will melt, causing fire or electric shock.
- When the printer will not be used for a long period, be sure to remove the plug of the power cord from the outlet to guarantee safety.
- Isolate the AC power source from other devices that generate noise.

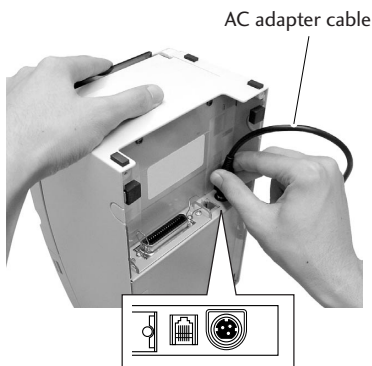

Flat side of the cable is up.

AC adapter type

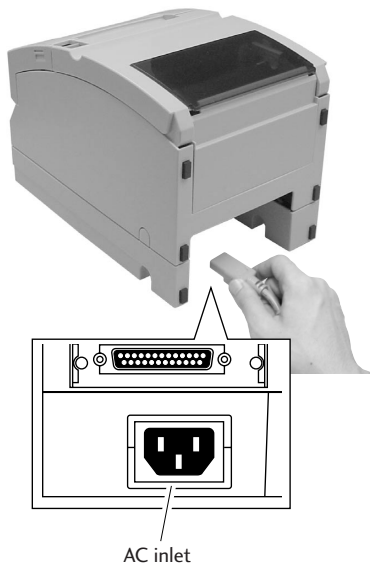

AC inlet

Built-in AC adapter type

Installation

This printer can be installed horizontally or vertically and can be wall mounted. But according to the model you are using, there may be restrictions on how it is installed. Refer to the following table.

	Horizontal	Vertical	Wall Mount
Standard model (AC adapter type)	Yes	No	Yes*2
Standard model (Built-in AC adapter type)	Yes	Yes*1	Yes*2
Auto cutter equipped model (AC adapter type)	Yes	No	Yes*2
Auto cutter equipped model (Built-in AC adapter type)	Yes	Yes*1	Yes*2
Auto cutter and rewinder equipped model (AC adapter type)	Yes	No	No
Auto cutter and rewinder equipped model (Built-in AC adapter type)	Yes	No	No

*1: Accessory rubber feet must be used to prevent slipping.

*2: The optional specialized wall mount unit is necessary to mount it on the wall.

Vertical installation and wall mounted installation

To install the printer vertically or wall mounted, remove the Chassis Platen L Spring used to open the rear cover. And reverse the LED name sheet on the operation panel to use it with the vertically installed and wall mounted display.

■ Removing the Chassis Platen L Spring

1. Open the rear cover. Do this carefully, because the cover snaps open vigorously.
2. Lift part A with the fingers of your right hand.
3. Switch the Chassis Platen L Spring that you have raised from your right thumb to your left thumb to hook the protrusion on the end of the Chassis Platen L Spring inside part B of the printer.

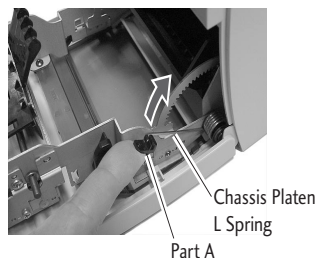

Caution

Chassis Platen L Spring with strong repulsive force is used. Be very careful that it does not slip off your finger causing an injury.

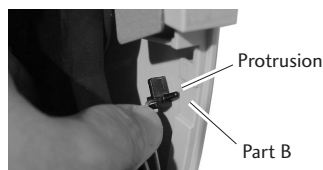

■ LED Name Sheet

Remove and reverse the sheet then reinsert the protruding part of the center of the sheet in the printer and push in both ends.

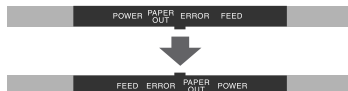

Setting the Paper Near End Sensor

Change the sensor location according to the way the printer is installed and the interior diameter of the roll paper you are using. Referring to the following table, set it at a location suited to the usage environment by moving it to the left and right while pushing the concave part of the center of the sensor with your finger. (When shipped from the factory, it is set at $\phi 24\text{mm}$.)

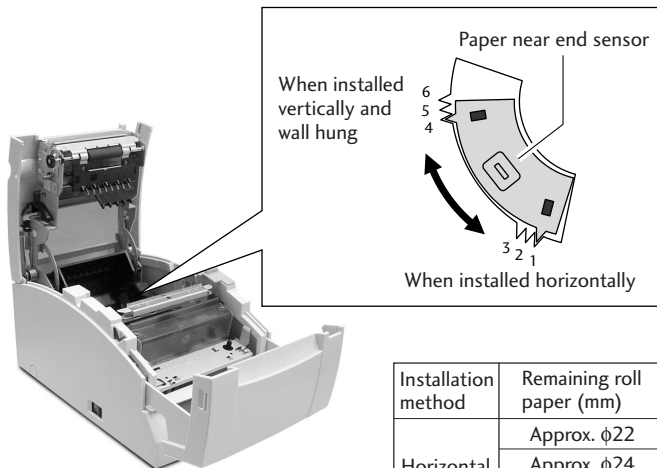

Installation method	Remaining roll paper (mm)	Sensor location
Horizontal	Approx. $\phi 22$	1
	Approx. $\phi 24$	2
	Approx. $\phi 27$	3
Vertical (wall mounted)	Approx. $\phi 27$	4
	Approx. $\phi 24$	5
	Approx. $\phi 22$	6

Caution

- The remaining roll paper (external diameter of the roll paper) differs greatly according to the type of roll paper used. Use these values only as guidelines.
- When the sensor has detected the remaining roll paper during printing, the printer stops printing after it has printed all the data that it had received.
- If you are using a model with parallel (IEEE1284) interface specifications, you can select sensor enabled/disabled in Soft SW Setting Mode.
- If you are using a model with serial (RS232C) interface specifications, it is always enabled.

Setting the Paper Width and Printing Line Column Number

The printing dot line columns are changed as follows by setting the “Paper Width” of the roll paper used, the “Number of col.” and the “Font Select” in Soft SW Setting Mode. For details about setting, see Soft SW Setting Mode (page 35).

When setting Paper Width of 76.2mm

Soft SW Setting Mode		Space between characters	Printing line columns	Full columns
Number of col.	Font Select			
40/33	9×9 dots	3 dots	33 columns	400 dots
	7×9 dots	3 dots	40 columns	
42/35	9×9 dots	2 dots	35 columns	386 dots
	7×9 dots	2 dots	42 columns	

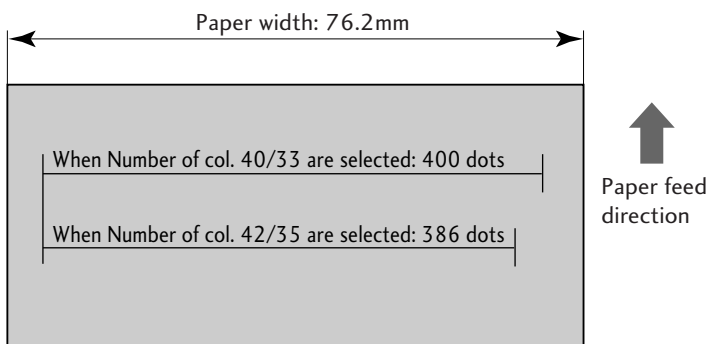

Setting Paper Width and Printing Line Columns

When setting Paper Width of 69.5mm

Soft SW Setting Mode		Space between characters	Printing line columns	Full columns
Number of col.	Font Select			
40/33	9×9 dots	3 dots	30 columns	360 dots
	7×9 dots	3 dots	36 columns	
42/35	9×9 dots	2 dots	32 columns	
	7×9 dots	2 dots	40 columns	

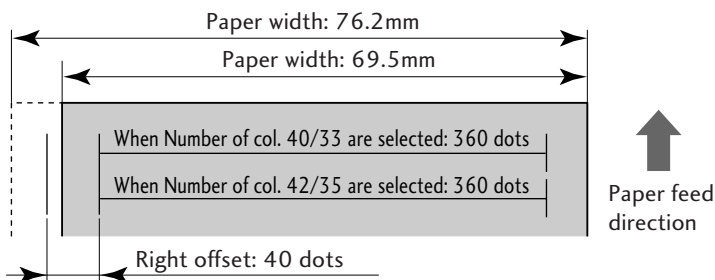

When setting Paper Width of 57.5mm

Soft SW Setting Mode		Space between characters	Printing line columns	Full columns
Number of col.	Font Select			
40/33	9×9 dots	3 dots	25 columns	300 dots
	7×9 dots	3 dots	30 columns	
42/35	9×9 dots	2 dots	27 columns	298 dots
	7×9 dots	2 dots	33 columns	

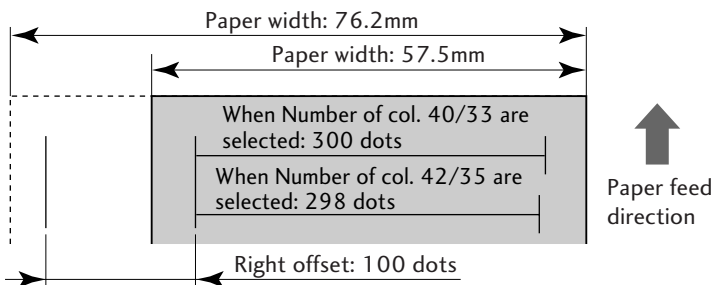

Installing the Ribbon Cassette

1. Open the front cover of the printer.
Insert your fingers into the dents at opposite ends of the front cover to open it with both hands.

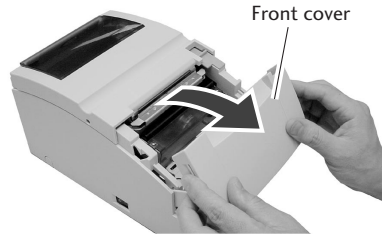

2. Turn the ribbon cassette knob in the direction shown by the arrow to fully stretch the ribbon.

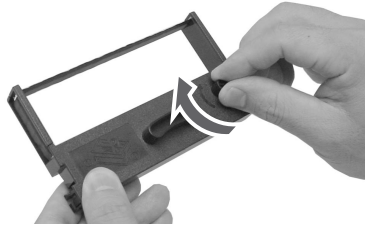

3. Insert the cassette into the printer until a click is heard so that the ribbon is between the paper cut bar and the print head cover. If it is difficult to insert, turn the ribbon cassette knob again.

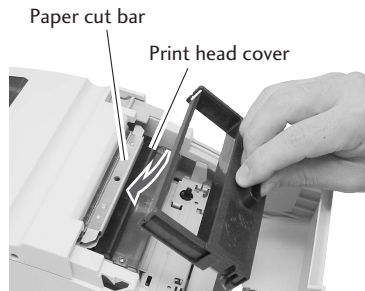

4. Close the front cover.



Caution

Be very careful not to let your hands touch the print head cover when replacing the ribbon cassette. When the print head has become heated, there is a danger of it burning your hand.

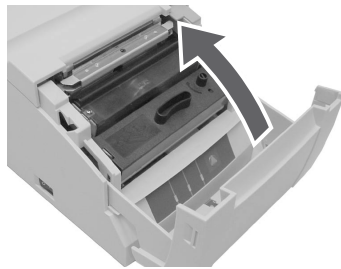

Installing Roll Paper

The following are the types of roll paper that can be used by this printer.

Types: 1P roll paper

2P copy roll paper (1 original + 1 copy)

3P copy roll paper (1 original + 2 copies)

(2P and 3P copy roll paper are only usable on models equipped with auto cutter and rewinder.)

Paper widths: 76.2 (± 0.7)/69.5 (± 0.6)/57.5 (± 0.5)mm

Roll diameter: $\phi 30$ mm to $\phi 83$ mm

Core diameter: Interior diameter $\phi 10^{+2}_0$ mm, exterior diameter $\phi 27$ mm or less

Paper thickness: 1P 0.06 to 0.085mm

Copy paper 0.05 to 0.20mm (total thickness)

But the total thickness that can be cut is from 0.05 to 0.14mm.

Standard and Auto Cutter Equipped Models

Installation method

1. Pull the rear cover open lever towards you to open the rear cover.

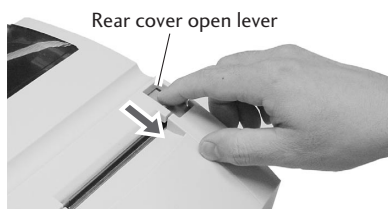

2. Set the attached partition in place if the roll paper you are using is 69.5mm wide or 57.5mm wide.

Change the paper width by changing the value set as the width using the Soft SW Setting Mode.

(See page 35)

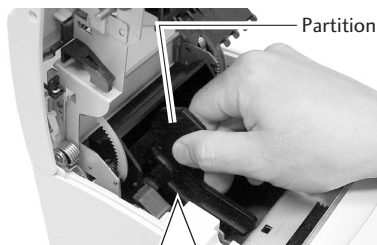

Caution

When setting the roll paper, be careful not to cut your hand on the edge of the paper.

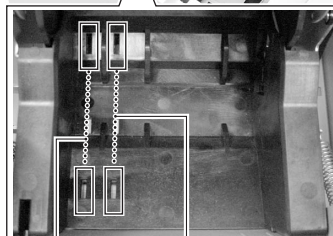

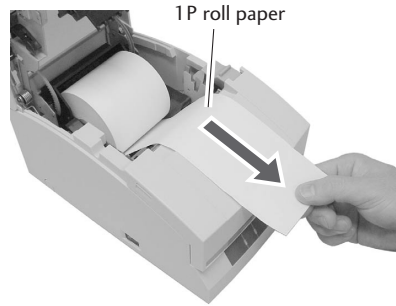

Location set for width of 57.5mm
Location set for width of 69.5mm

3. Place the roll paper and pull the end of the roll paper directly towards you as shown in the figure.
Hold the center of the roll paper to pull it as straight as possible so that one of the sides of the paper does not slacken.

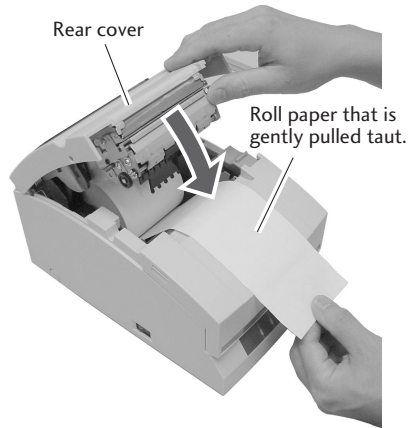

4. Maintaining tension in the roll paper, firmly close the rear cover until you hear a click.
Paper feeds automatically and stops at the print start position.



 **Caution**

Be very careful not to let the rear cover catch your hands when closing the rear cover.



5. Tear off surplus paper by holding one side of the end of the roll paper and pulling it towards you.



 **Caution**

Do not insert any foreign objects such as a paper clip into the cutter unit.



Installing Roll Paper

Auto Cutter and Rewinder Equipped Model

Installation Method

1. Pull the rear cover open lever towards you to open the rear cover.

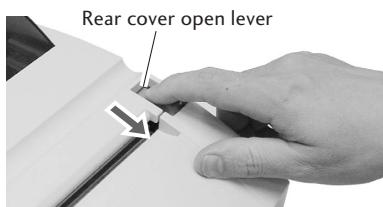

2. Then pull the platen open lever towards you to open the platen unit.

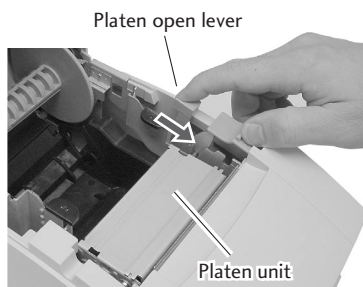

3. Set the attached partition in place if the copy roll paper you are using is 69.5mm wide or 57.5mm wide. Change the paper width by changing the value set as the width using the Soft SW Setting Mode. (See page 35)

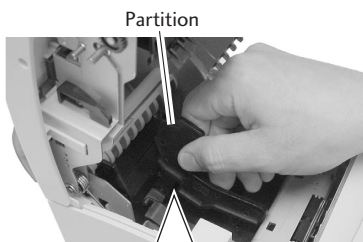

Caution

When setting the roll paper, be careful not to cut your hand on the edge of the paper.

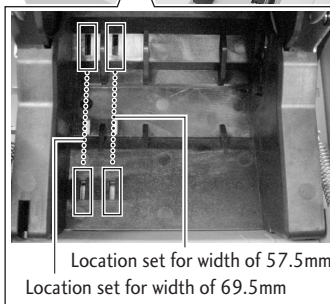

4. After removing the rewinder shaft, install the copy roll paper and pull the end of the roll paper straight towards you for about 30cm as shown in the figure.

Hold the center of the roll paper to pull it as straight as possible so that one of the sides of the paper does not slacken.

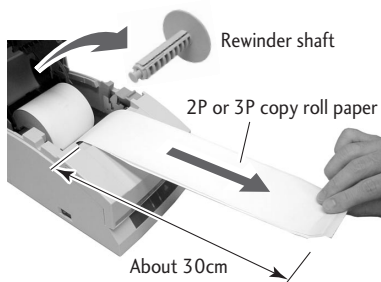

5. Maintaining light tension in the copy roll paper, firmly close the platen unit until you hear a click.



Caution

Be very careful not to let your hands touch the blade on the paper cutter bar.

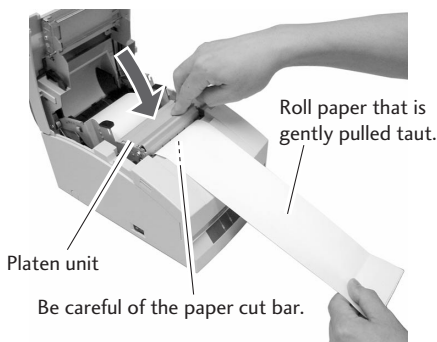

6. Set one side of the copy roll paper (copy side) on the rewinder shaft as shown in the figure, and tightly wind it about 2 rotations in the direction shown by the arrow.

Check to make sure that the copy roll paper rotates with the rewinder shaft.

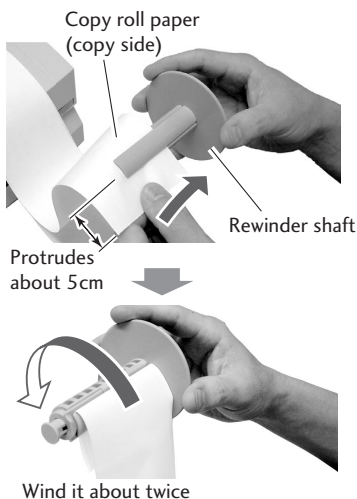

Installing roll paper

7. Being careful not to let the copy roll paper set on the rewinder shaft slacken, place the roll paper in the grooves on both sides. Turn the flange on the rewinder shaft in the direction shown by the arrow and make sure that the copy roll paper rotates with the rewinder shaft.

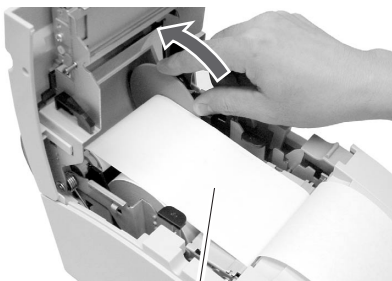

Taking up slack while checking that the copy roll paper winds.

8. With the other side of the copy roll paper (original side) pulled lightly taut, close the rear cover firmly until you hear a click. Hold the center of the roll paper to pull it as straight as possible so that one of the sides of the paper does not slacken. Paper feeds automatically and stops at the print start position.

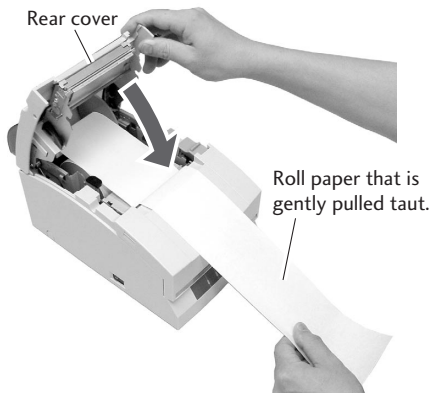

Caution

Be very careful not to let the rear cover catch your hands when closing the rear cover.



9. Tear off surplus paper by holding one side of the end of the roll paper and pulling it towards you.



Caution

Do not insert any foreign objects such as a paper clip into the cutter unit.

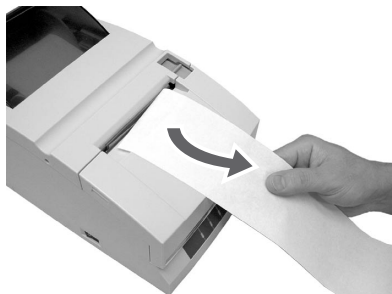

Operation when the cover is opened and closed

Operation when the front cover is opened and closed

Opening: During printing, the printing stops and if it is in red printing status, the ribbon is switched to the black ribbon status, moves to the centering location, and becomes the condition you can replace the ribbon cassette.

Closing: If it was red printing status when it was opened, the ribbon returns to red status and if there is printing data, printing restarts.

Operation when the rear cover is opened and closed

Opening: During printing, the printing stops and the ribbon moves to the centering location and remains in stand by. On models equipped with a rewinder, if the cover is opened with paper set, the paper is fed forward about 1 inch then returns to the centering position.

Closing: After print operation and cut operation have been initialized, it performs paper feed check, and if there is printing data, printing restarts.



Caution

- If a cutter problem is caused by a paper jam etc., the printer may stop with the cutter blade protruding so that the rear cover cannot be opened. In this case, press the FEED switch to eliminate the cutter problem without trying to force it open. If the problem is not eliminated by pressing the switch, insert a screw driver in the hole on the left side surface of the rear cover and rotate it to manually restore the cutter blade, then open the cover. (The blade will be restored by turning it to either the left or the right.)
- Be careful of the manual paper cut bar in particular, to make sure that your fingers are not caught when opening and closing the cover.
- Opening the rear cover during printing causes malfunctions of the printer head or cutter unit. Make sure that printing has stopped before you open the rear cover.
- To close the rear cover, close it while holding the end of the paper so that the paper is not slack or bent inside the printer.

Maintenance Mode

The settings of the printer can be changed according to its usage environment in maintenance mode. And it is also possible to change their settings back to the initial factory shipping setting or to adjust the cut position after printing in this mode. And the content of the settings can be confirmed in demonstration printing mode. To change the settings in maintenance mode, print and check the present settings.

Demonstration printing mode

Setting the mode

Turning the power on while pressing the FEED switch with the front cover and the rear cover both closed starts demonstration printing mode and the “demonstration printing and the present printing settings” are printed.

Setting maintenance mode

1. Set maintenance mode by turning on the power while pressing the FEED switch with the front cover open and the rear cover closed, then releasing the FEED switch.

2. The POWER LED flashes as the printer enters maintenance mode. Close the front cover in this status.

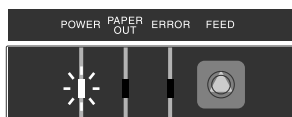
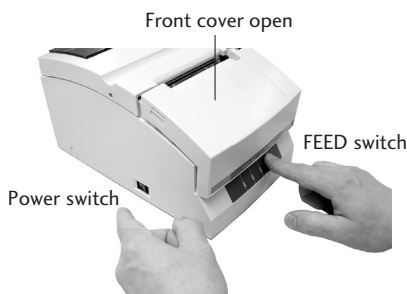

Types of maintenance mode

There are the following four types of maintenance mode.

Each mode is selected according to the number of times the FEED switch is pressed from maintenance mode.

- **HEX Dump Mode:** Press the FEED switch 0 times and reopen and close the front cover.
- **Soft SW Setting Mode:** Press the FEED switch 1 time and reopen and close the front cover.
- **Initial Factory Shipping Mode:** Press the FEED switch 2 times and reopen and close the front cover.
- **Cut Position Adjustment Mode:** Press the FEED switch 3 times and reopen and close the front cover.

HEX Dump Mode

Setting the mode

If the front cover is reopened and closed in maintenance mode (POWER LED is flashing), the POWER LED stops flashing and remains lit, and the printer enters HEX Dump Mode.

After printing the title, it stands by to receive data.

To leave HEX Dump Mode, turn off the printer power then turn the power on again with the front and rear covers both closed.

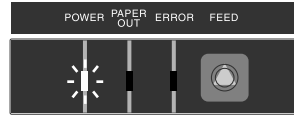

Reopening and closing the front cover:

Flashing → Lit

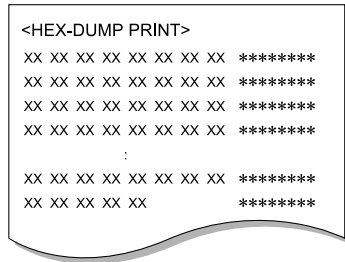

Soft SW Setting Mode

Setting the mode

1. If the FEED switch is pressed once in maintenance mode (POWER LED is flashing), the POWER LED and PAPER OUT LED start flashing.

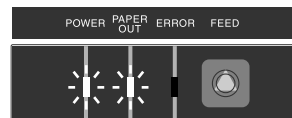

Flashing Press once

2. If the front cover is reopened and closed in this status, the POWER LED and PAPER OUT LED stop flashing to and remain lit, and after the title and top items have printed, it enters Soft SW Setting Mode.

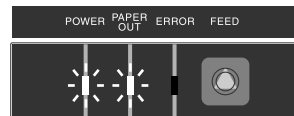

Reopening and closing the front cover:

Flashing → Lit

Soft SW Setting Mode

Operating method

Press the FEED switch (less than 2 seconds):

The setting changes.

The present set value is changed and the same item is reprinted. (Press the FEED switch, and when the buzzer sounds once, release it.)

Pressing the FEED switch continuously (2 seconds or more):

Moves to the next item.

It prints the present set value of the next item. (Press the FEED switch, and when the buzzer sounds three times, release it.)

Opening/closing the front cover:

After saving the set values, it reprints all items from the top and returns to normal power on status.

- * If the power is turned off without opening and closing the front cover, the setting change is invalid.
- * If the paper runs out during the change, set the paper and close the rear cover to continue the process.

<Soft-Switch Setting>	
Press Feed	-- Change PARM.
Press Feed For 2S	-- Next Item
F.Cover Open/Close	-- Save & Exit

<Soft Control-SW>	
Command Type	--EPSON
Number of Col.	--40/33
Font Select	--7×9
Paper Plies	--OFF
Paper End	--ENB
Paper Near-End	--ENB
Slashed Zero	--OFF
Print Direct.	--BI-DIR
Auto LF	--OFF
Code Page	--437
Buffer Size	--4K
Init Signal	--ENB
Buzzer	--ON

<Interface-SW>	
Baud Rate	--9600
Data Length	--8bit
Parity Bit	--NONE
Stop Bit	--1bit
Protocol	--DTR

<Mechanical-SW>	
Paper Width	--76.2
Auto-Cutter	--PAR.
Color Ribbon	--ON
Take-Up Device	--ON
Black Mark	--DIS

Command Type	--EPSON
Command Type	--STAR
Number of Col.	--40/33
Font Select	--7×9
Font Select	--9×9

Operations

Press the FEED Switch →

Press and hold the FEED Switch →

Press and hold the FEED Switch →

Press the FEED Switch →

Example of a change of the Command Type to STAR and the Font Select to 9×9.

Setting Mode Table

■ Soft Control-SW

Set item	Initial value	Setting value	Remarks
Command Type	EPSON	EPSON STAR CBM1 CBM2	The emulation is selected from EPSON/STAR/CBM1/CBM2.
Number of Col.	40/33	40/33 42/35	Number of full dot in full column is 200 dots. For the number of line columns based on the paper width, see "Setting the Paper Width and Printing Line Column Number".
Font Select	7x9	7x9 9x9	The initial font size is selected immediately after the power is turned on.
Paper Plies	OFF	OFF 2P 3P	Copy mode is selected. OFF/2P/3P can be selected. But when 3P is set, the printing speed is low.
Paper End	ENB	ENB DIS	The PE signal enabled/disabled is set at paper end when only the centro-interface is set as enabled. During enabled status, BUSY, PE, FAULT are output and printing stops at paper out. During disabled status, only BUSY is output and printing stops at paper out.
Paper Near-End	ENB	ENB DIS	The PE signal enabled/disabled is set at paper near end when only the centro-interface is set as enabled. During enabled status, PE, FAULT are output and printing continues. During disabled status, nothing is output and printing continues.
Slashed Zero	OFF	OFF ON	It sets whether or not slash is used with the numeral 0 (zero).
Print Direct.	BI-DIR	BI-DIR UNI-DIR	Designates printing direction. When BI-DIR is selected, printing starts from the closer of the left and right ends of the next printing line from the print stop location. During UNI-DIR printing is usually done from the left end.
Auto LF	OFF	OFF ON	The LF operation during CR code reception is selected. When ON, LF does not operate; when OFF, LF operates. CR: Carriage Return LF: Line Feed
Code Page	437	437, KATAKANA, 850, 860 863, 865 852, 866 857, 858 WPC1252	The code page is selected.

Soft SW Setting Mode

Set item	Initial value	Setting value	Remarks
Buffer Size	4k	40byte 4Kbyte	The receiving buffer size is selected.
Init Signal	ENB	ENB DIS	Selects enabled (ENB)/disabled (DIS) of the printer initialized signal (PRIME) during centro-interface. Selects enabled (ENB)/disabled (DIS) of the 25pin reset signal during serial interface.
Buzzer	ON	ON OFF	Selects buzzer sound when an abnormality occurs as enabled (ON)/disabled (OFF).

■ Interface-SW (Displayed only when the serial board is mounted)

Set item	Initial value	Setting value	Remarks
Baud Rate	9600	19200 9600 4800 2400 1200	Sets the baud rate of the serial interface.
Data Length	8 bit	8 bit 7 bit	Sets the character length of the serial interface.
Parity Bit	NONE	NONE EVEN ODD	Sets the communication parity of the serial interface.
Stop Bit	1 bit	1 bit 2 bit	Sets the stop bit of the serial interface.
Protocol	DTR	DTR X-ON-OFF	

■ Mechanical-SW

Set item	Initial value	Setting value	Remarks
Paper Width	76.2	76.2 69.5 57.5	Selects the paper size.
Auto-Cutter	PAR.	OFF FREE FULL PAR.	Selects the cutter operation. When it is OFF, the FULL/PAR. commands do not start cutting. In FREE status, cutting is done according to the FULL/PAR. commands. In FULL status, full cut is always done by both the FULL/PAR. commands. In PAR status, partial cutting is always done by both the FULL/PAR. commands.
Color Ribbon	ON	ON OFF	Selects the color function. During OFF, the change color command is ignored.

Set item	Initial value	Setting value	Remarks
Take-Up Device	ON	ON OFF	Selects the rewinder function. During OFF, the rewinder motor does not operate.
Black Mark	DIS	DIS TYPE1 TYPE2	Selects enabled (TYPE1, TYPE2)/disabled (DIS) of the black mark control function. In TYPE1 status, auto paper length measuring operation is done and the black mark is fed to the paper cut position when the power is turned on. GS FF/FF commands are available in the status. It is used for formatting the black mark at the edge of the page. In TYPE2 status, measuring operation is not done when the power is turned on. The auto paper length paper measuring, initial paper positioning and paper cutting operations are controlled by the command from a host PC. FS(L command only is available in the status. It is used for formatting the black mark in the middle of the page. (TYPE2 status is not available in STAR and CBM1/2 modes.)

Concerning Mechanical-SW operation

Functions that are not supported by the specifications at time of shipping have no impact on printer operation even when the settings are changed.

Examples) Items set for the Auto-Cutter in models that are not equipped with an Auto-Cutter.

Change of the setting of the Take-Up Device in models to which rewinder specifications do not apply.

Concerning Auto-Cutter operation

The minimum cutting interval is 1/2 inch (3 lines with 6LPI).

Once a cut command has been executed, even if a command is sent before the paper has fed at least 1/2 inch, the cut command is ignored so the cut action cannot be executed.

Initial Factory Shipping Mode

Setting the mode

1. Pressing the FEED switch twice in maintenance mode (POWER LED is flashing) causes the POWER LED, PAPER OUT LED, and the ERROR LED to begin to flash.

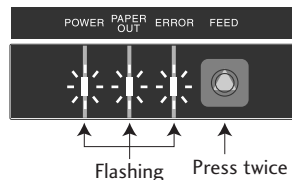

Initial Factory Shipping Mode

2. Reopening and closing the front cover in this status switches the POWER LED, PAPER OUT LED, and the ERROR LED from flashing to continuously lit status.
3. Pressing the FEED switch for 3 seconds or more restores settings to the factory shipping (initialized) status.

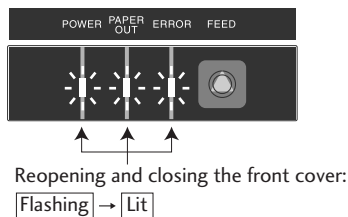

Cut Position Adjustment Mode

Setting the mode

1. Pressing the FEED switch 3 times in maintenance mode (POWER LED is flashing) causes the POWER LED and the ERROR LED to begin to flash.

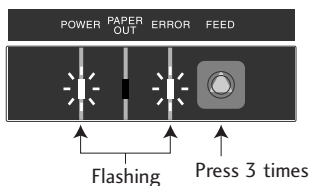

2. Reopening and closing the front cover in this status switches the POWER LED and the ERROR LED from flashing to continuously lit status and enters Cut Position Adjustment Mode.

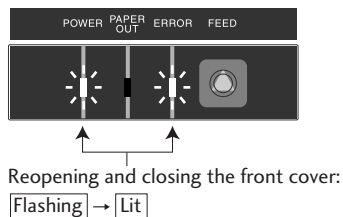

Operating Method

Pressing the FEED switch (less than 2 seconds):

The present value is changed in units of $\pm 1/144$.

Opening and closing the front cover:

The \pm of the adjustment direction changes. Immediately after entering adjustment mode, the value is changed in the + direction. Opening then closing the front cover changes the \pm of the adjusted value.

Pressing and holding the FEED Switch (2 seconds or more):

The present value is saved and the printer enters normal power on status.

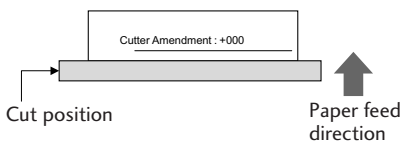

Adjustment range: -035 to $+035$
Initial value: $+000$

Error Indicators

When this printer malfunctions or jams etc., the type of problem is indicated by a buzzer and by lit or flashing LED on the operating panel.

In error status, the error indication can be cancelled by pressing the FEED switch.

Error indicator table

Type of Error	LED indicator	LED indicator	Operation and restoration method
Paper end	POWER PAPER OUT ERROR	Lit Lit Off	During printing, printing stops and the printer goes offline. Replace the paper and close the cover to return the printer online.
Paper near end	POWER PAPER OUT ERROR	Lit ○ ○ ● ● Off	In centro-interface, when the Paper Near-End on the Soft SW is set as enabled, PE, FAULT are output and printing continues. When it is set as disabled, nothing is output and printing continues.
Rear/front cover open	POWER PAPER OUT ERROR	Lit Depends on status Lit	During printing, printing is immediately stopped and the printer goes offline. Close the cover to restore the printer to online status.
Head hot	POWER PAPER OUT ERROR	Lit Depends on status ○ ○ ● ●	Cooling starts. After the temperature has fallen, it is automatically restored and printing restarts. The buzzer continues to sound until the error is cancelled by the FEED switch.
HP abnormal	POWER PAPER OUT ERROR	○ ○ ● ● ○ ○ ● ● ○ ○ ● ●	The printer goes offline. Remove the paper jam or other problem and press the FEED switch to restore the printer to online status.
Black mark abnormal	POWER PAPER OUT ERROR	○ ○ ● ● ○ ○ ● ● ● ● ○ ○	The buzzer continues to sound until the error is cancelled by the FEED switch.
Cutter abnormal position detection	POWER PAPER OUT ERROR	○ ○ ● ● ● ● ○ ○ ● ● ○ ○	
Hardware abnormal RAM read-write	POWER PAPER OUT ERROR	Off ● ○ ● ○ ● ○ ● ○	Turn off the power then turn it on again. If the error continues, notify the dealer where you purchased the printer or service personnel after turning off the power.
Hardware abnormal FROM read-write	POWER PAPER OUT ERROR	Off ○ ● ○ ● ● ○ ● ○	
24V abnormal	POWER PAPER OUT ERROR	Off Off ● ○ ● ○	

- There are no RS232C communication error or front cover opened/closed detection indicators.
- If the buzzer setting is OFF in Soft SW Setting Mode, the buzzer does not sound.

○ : Lit, ● : Off

Clearing a Paper Jam

Clearing method

1. Turn off the power and open the rear cover.

If the rear cover cannot be opened

When there is a cutter problem, the printer may stop with the cutter blade protruding so that pressing the FEED switch fails to clear the error. When this happens, restore the cutter blade manually by inserting a screwdriver into the hole on the left side surface of the rear cover and rotating it, then open the cover (the blade will be restored whether you turn it to the left or right). Turn the screw driver so that the projections on both ends of the blade of the cutter are returned to the back of the printer (direction shown by the arrow).

2. Remove all the jammed paper (temporarily remove the roll paper that is installed in the printer).
3. Close the rear cover and turn on the power. The auto cutter operation will be initialized and the error cleared.



Caution

When removing the jammed paper, be careful not to touch the area around the print head nor the cutter blade. If you do you will be burned or cut.

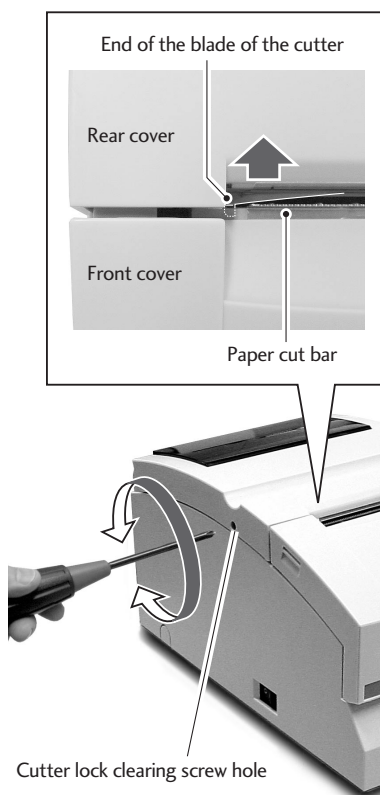

Trouble Shooting

When there is trouble with this printer, take action to clear up the trouble according to the following table.

If this action does not clear up the trouble, notify the dealer where you purchased the printer or service personnel.

	Symptom	Check	Action
1	Paper jam	Check for a jam at the paper ejection opening. If you cannot open the rear cover, do check number 2.	Remove all the jammed paper. Remove the roll paper from the printer and put it back again.
2	Rear cover does not open	Check to see if the blade of the auto cutter is protruding.	<p>Insert a Phillips screwdriver (+) into the cutter lock cancel use feed hole on the printer and turn it clockwise or counter clockwise. (Use a # 1 screwdriver.)</p> <p>Rotate the screwdriver while watching the paper ejection opening and stop turning it when both ends of the blade are fully retracted. (→ P.42)</p> <div style="border: 1px solid black; padding: 5px;"> <p> Caution</p> <p>Do not try to force the rear cover to open. If you do, the printer will be damaged and you will be cut by the blade.</p> </div>
3	Ribbon does not feed correctly	Turn the knob on the ribbon cassette.	After turning the knob until the ribbon feeds smoothly, reset the ribbon cassette. If you cannot turn the knob, the ribbon may be jammed inside the cassette. If the situation does not improve, replace it with a new ribbon cassette.
4	The paper is not cut	Check to make sure that the rear cover and front cover are closed.	If one of the covers is open, close it. If the paper still cannot be cut after you have closed the cover, notify the dealer where you purchased the printer or service personnel.

Specifications

Printing mode	Serial impact dot matrix
Printing direction	Bi-directional
Head pins	9 pins (ϕ : 0.3mm, Pin interval; 1/72inch)
Printing line columns	Paper width of 76.2mm 40/42 or 33/35 columns Paper width of 69.5mm 36/40 or 30/32 columns Paper width of 57.5mm 30/33 or 25/27 columns 200/400 dots (full dot/including half dot)
Font configuration	7×9 or 9×9 dots
Character types	ASCII (96 characters), International characters, Katakana Code pages: 437, KATAKANA, 850, 860, 863, 865, 852, 866, 857, 858, WPC1252
Panel/switches	1 switch (FEED), 3 LED (POWER/PAPER OUT/ERROR), 1 buzzer
Printing speed	Printing: 240CPS (3P paper 200CPS) Through-put: 76.2mm wide, 40 columns (7×9+3sp, 6LPI) 5.0LPS 69.5mm wide, 36 columns (7×9+3sp, 6LPI) 5.4LPS 57.5mm wide, 30 columns (7×9+3sp, 6LPI) 6.0LPS
Paper feed	Friction feed Minimum pitch: 1/144 inch Paper feed speed: 40LPS (6LPI)
Paper	Types: 1P roll paper 2P copy roll paper (1 original + 1 copy) 3P copy roll paper (1 original + 2 copies) * When 3P, printing speed falls 16% Paper widths: 76.2 / 69.5 / 57.5 (± 0.5)mm Roll diameter: $\phi 30$ mm to $\phi 83$ mm Core diameter: Interior diameter $\phi 10^{+2}_0$ mm, exterior diameter $\phi 27$ mm or less Paper thickness: 1P 0.06 to 0.085mm Copy paper 0.05 to 0.20mm (total thickness) But the total thickness that can be cut is from 0.05 to 0.14mm. * No glue on the core or end of the paper.
Ribbon	Method: special ribbon cassette Colors: Single color (purple, black), 2 color (black and red) Life: Purple, approx. 4 million characters (continuous printing at 25°C) Black, approx. 3 million characters (continuous printing at 25°C) Red/black, black 1.5 million characters, Red 750,000 characters
Interface	Standard model: 2 models, either RS232C or IEEE1284
Emulation	ESC/POS (Page mode) CBM mode, STAR mode

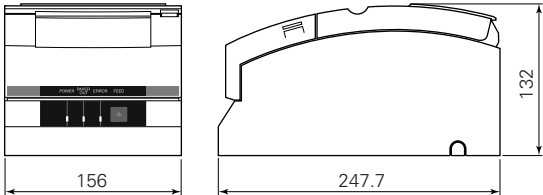
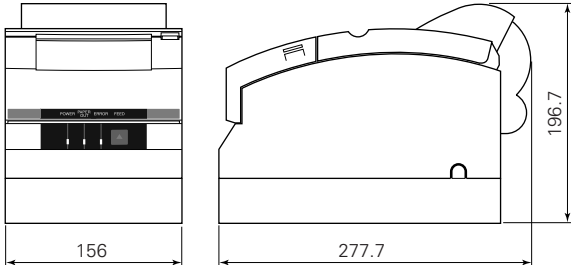
Data buffer	Receiving buffer: 40 or 4K bytes NV bit image: 128K bytes User NV memory: 8K
Features	Paper-drop-in style Auto cutter function (full cut/partial cut) Rewinder function Black mark sheet compatible Copy (2P/3P) paper compatible DKD (Drawer Kick Driver) function ASB (Auto Status Back) function
Power	CD-S500A type Input: DC24V, 1.0A CD-S500S type Input: AC100V-240V, 0.55A-0.35A, 50/60 Hz Power consumption: 24W
External dimensions	<p>Standard model: 156(W) x 247.7(D) x 132(H) mm</p>  <p>AC adapter and rewriter equipped model: 156(W) x 277.7(D) x 196.7(H) mm</p> 

Specifications

Printer weight	Standard model: 2.20kg Auto cutter equipped model: 2.30kg Auto cutter and rewinder equipped model: 2.45kg But these exclude the AC adapter, AC case, ribbon, and paper.
Environmental conditions	<p>During operation: Temperature 0 to 50°C Humidity 10 to 90%RH (no condensation)</p> <p>During storage : Temperature -20 to 70°C Humidity 5 to 90%RH (no condensation)</p>
Durability	7.5 million lines (MCFB) Head lifetime 150 million characters Cutter lifetime 1 million cuts
Applicable standard	UL, C-UL, FCC Class A, TÜV-GS, CE Marking, CCC

Ribbon Cassette

Cassette shape	<p>Single color specification, color (purple) : IR-31P color (black) : IR-31B</p> <p>Two color specification, colors (red/black) : IR-31RB</p>
Lifetime	<p>Single color specification, color (purple) : approx. 4 million characters color (black) : approx. 3 million characters</p> <p>Two color specification, colors (red/black): red approx. 750,000 characters/black approx. 1.5 million characters</p>

Be sure to use a recommended ribbon cassette in order to maintain printing quality and stabilize printer operation.

Paper

Use the following printing paper in order to maintain printing quality and stabilize paper feeding.

Roll paper	Paper width: 76.2±0.7mm (3±1/36 inch) 69.5±0.6mm (3±1/36 inch) 57.5±0.5mm (2.26±0.02inch) Roll diameter: φ30mm to φ83mm Core diameter: Interior diameter φ10 ⁺³ ₀ mm, exterior diameter φ27mm or less Paper thickness: 0.06 to 0.085mm Weight: 52.3 to 64.0 g/m ² (JIS P8124) (45 to 55kg/1,000 sheets/788mm x 1,091mm) Recommended paper: Register paper (Oji Paper Co., Ltd.) or equivalent
Pressure sensitive paper	Non-carbon 2P/3P paper, 1 original + 1 copy /2 copies Paper width: 76.2±0.7mm (3±1/36 inch) 69.5±0.6mm (3±1/36 inch) 57.5±0.5mm (2.26±0.02 inch) Roll diameter: φ30mm to φ83mm Core diameter: Interior diameter φ10 ⁺³ ₀ mm, exterior diameter φ27mm or less Paper thickness: 0.05 to 0.20mm But the total thickness that can be cut is from 0.05 to 0.14mm. Recommended paper: 2P NCR Super (Mitsubishi Paper Mills Limited) (prints in blue) or equivalent

Cautions concerning the roll paper

Starting to wind the roll paper (interior end) processing (with center core)

- It must not be folded and its internal diameter must be even.
- It must not be rolled back.
- There must be no glue on its center core.
- It must be wound with its printing side facing outwards.
- When it is 2P paper, there must be no glue between the top and bottom sheets.
- In the case of 3P paper, there must be no glue on the top, middle, or bottom papers.
- Use pressure sensitive paper with total thickness no greater than 0.20mm and remember that the printer will not cut paper with total thickness greater than 0.14mm.

If you use pressure sensitive paper with total thickness greater than 0.14mm, either do not use the cutter or else rewind the bottom paper with the rewinder to reduce the total thickness (top paper + middle paper) to 0.14mm or less.

Interface

Serial (RS232C) interface

■ Pin assignment

PIN No.	Signal Name	Direction	Function
1	FG	-	Frame ground
2	TXD	Output	Data transmission
3	RXD	Input	Data reception
4	RTS	Output	Same as DTR (20pin)
6	DSR	Input	Host reception enabled status HIGH-READY/LOW-NOT READY [During DTR/RTS control] The printer transmits data after it is confirmed that DSR is high. (But transmission by DLE EOT, GS a) [During XON/XOFF control] Printer does not confirm DSR.
7	SG	-	Signal ground
20	DTR	Output	Printer READY/BUSY status HIGH-READY/LOW-BUSY [During DTR/RTS control] When the printer is in reception enabled status, it is READY, when it is reception disabled, it is BUSY. Printer status 1) BUSY until completion of initial settings when the power is turned on 2) BUSY in normal OFFLINE status 3) BUSY in OFFLINE status during PE 4) BUSY in OFFLINE status when other errors occur 5) BUSY when the reception buffer is full 6) BUSY during Self-Print [During XON/XOFF control] Always HIGH-READY except under the following conditions 1) Until completion of initial settings when the power is turned on 2) During Self-Print
25	INIT	Input	Printer RESET (1 ms or more is higher)

■ Buffer Full Control

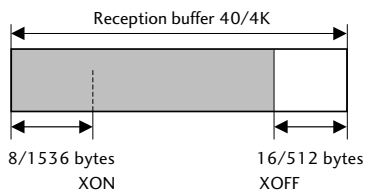

Overrun/Buffer size: 16/512 bytes
XOFF cancel size: 8/1536 bytes

■ Connection with HOST

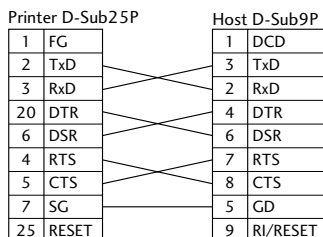

Parallel (IEEE1284) Interface

■ Pin assignment

PIN No.	Direction	Function		
		Compatibility Mode	Nibble Mode	Byte Mode
1	Input	*Strobe	HostCLK	HostCLK
2	Input/Output	Data0	Data0	Data0
3	Input/Output	Data1	Data1	Data1
4	Input/Output	Data2	Data2	Data2
5	Input/Output	Data3	Data3	Data3
6	Input/Output	Data4	Data4	Data4
7	Input/Output	Data5	Data5	Data5
8	Input/Output	Data6	Data6	Data6
9	Input/Output	Data7	Data7	Data7
10	Output	*ACK	PtrCLK	PtrCLK
11	Output	BUSY	PtrBUSY/Data3,7	PtrBUSY
12	Output	PE	AckDataReq/Data2,6	AckDataReq
13	Output	SELECT	Xflag/Data1,5	Xflag
14	Input	*AutoFeed	HostBUSY	HostBUSY
15	–	(NC)	(ND)	(ND)
16	–	GND	GND	GND
17	–	FG	FG	FG
18	Output	Logic-H	Logic-H	Logic-H
19–30	–	GND	GND	GND
31	Input	*INIT	*INIT	*INIT
32	Output	*FAULT	*DataAvail/Data0,4	*DataAvail
33	–	GND	(ND)	(ND)
34	Output	DK_STATUS	(ND)	(ND)
35	Output	+5V	(ND)	(ND)
36	Input	*Select-in	1284-Active	1284-Active

(*: Active Low)

■ Data Reception Timing

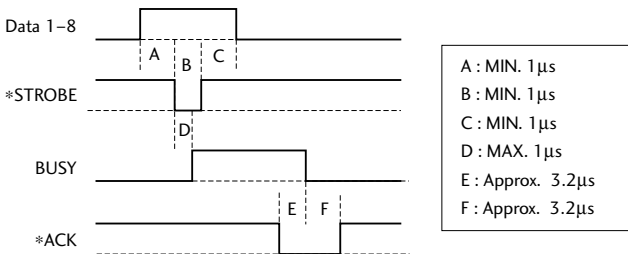

Parallel (IEEE1284) Interface

■ Timing when power is on

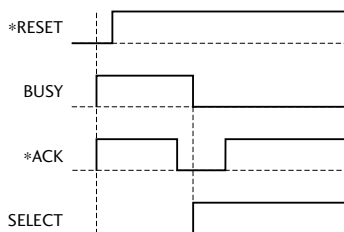

■ INIT signal timing

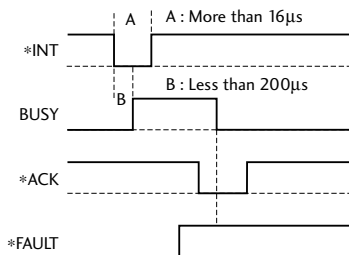

Drawer Kick-Out Interface

■ Pin assignment

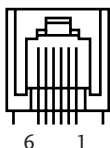

PIN No.	Direction	Function
1	-	Frame GND
2	Output	Drawer Kick-out Signal 1
3	Input	Drawer Open/Close
4	-	+24V
5	Output	Drawer Kick-out Signal 2
6	-	Signal GND

The ESC pm t1 t2 commands select either Drawer Kick-out Signal 1 or 2 to set the pulse time.

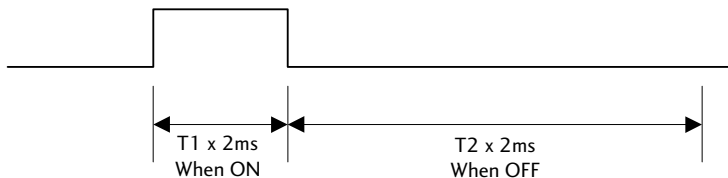

Note:

- T2 (when OFF) \geq T1 (when ON) is satisfied.
- The maximum amperage at +24V is up to 1A. When connected to one that exceeds 1A, the printer and connected equipment may be damaged.

WEEE MARK

En If you want to dispose this product, do not mix with general household waste. There is a separate collection systems for used electronics products in accordance with legislation under the WEEE Directive (Directive 2002/96/EC) and is effective only within European Union.

Ge Wenn Sie dieses Produkt entsorgen wollen, dann tun Sie dies bitte nicht zusammen mit dem Haushaltsmüll. Es gibt im Rahmen der WEEE-Direktive innerhalb der Europäischen Union (Direktive 2002/96/EC) gesetzliche Bestimmungen für separate Sammelsysteme für gebrauchte elektronische Geräte und Produkte.

Fr Si vous souhaitez vous débarrasser de cet appareil, ne le mettez pas à la poubelle avec vos ordures ménagères. Il existe un système de récupération distinct pour les vieux appareils électroniques conformément à la législation WEEE sur le recyclage des déchets des équipements électriques et électroniques (Directive 2002/96/EC) qui est uniquement valable dans les pays de l'Union européenne.

Les appareils et les machines électriques et électroniques contiennent souvent des matières dangereuses pour l'homme et l'environnement si vous les utilisez et vous vous en débarrassez de façon inappropriée.

Sp Si desea deshacerse de este producto, no lo mezcle con residuos domésticos de carácter general. Existe un sistema de recogida selectiva de aparatos electrónicos usados, según establece la legislación prevista por la Directiva 2002/96/CE sobre residuos de aparatos eléctricos y electrónicos (RAEE), vigente únicamente en la Unión Europea.

It Se desiderate gettare via questo prodotto, non mescolatelo ai rifiuti generici di casa. Esiste un sistema di raccolta separato per i prodotti elettronici usati in conformità alla legislazione RAEE (Direttiva 2002/96/CE), valida solo all'interno dell'Unione Europea.

Du Deponer dit product niet bij het gewone huishoudelijk afval wanneer u het wilt verwijderen. Er bestaat ingevolge de WEEE-richtlijn (Richtlijn 2002/96/EG) een speciaal wettelijk voorgeschreven verzamelsysteem voor gebruikte elektronische producten, welk alleen geldt binnen de Europese Unie.

Da Hvis du vil skille dig af med dette produkt, må du ikke smide det ud sammen med dit almindelige husholdningsaffald. Der findes et separat indsamlingssystem for udtjente elektroniske produkter i overensstemmelse med lovgivningen under WEEE-direktivet (direktiv 2002/96/EC), som kun er gældende i den Europæiske Union.

Por Se quiser deitar fora este produto, não o misture com o lixo comum. De acordo com a legislação que decorre da Directiva REEE – Resíduos de Equipamentos Eléctricos e Electrónicos (2002/96/CE), existe um sistema de recolha separado para os equipamentos electrónicos fora de uso, em vigor apenas na União Europeia.

Pol Jeżeli zamierzasz pozbyć się tego produktu, nie wyrzucaj go razem ze zwykłymi domowymi odpadkami. Według dyrektywy WEEE (Dyrektywa 2002/96/EC) obowiązującej w Unii Europejskiej dla używanych produktów elektronicznych należy stosować oddzielne sposoby utylizacji.



CITIZEN SYSTEMS JAPAN CO.,LTD.

6-1-12, Tanashi-cho, Nishi-Tokyo-shi, Tokyo 188-8511, JAPAN

Tel: +81-424-68-4608 Fax: +81-424-68-4997